

DETAILS

Product Number	CS14764_STRADA-2X2MX-VSM
Family	Strada
Type	Assembly
Color	clear
Diameter	90x90 mm
Height	13,13 mm
Style	square
Optic Material	
Holder Material	
Fastening	
Status	production ready
ROHS Compliant	Yes
Date Updated	31/05/2017



OPTICAL PROPERTIES

LED	Viewing Angle	Light Beam	Efficiency	cd/lm	Connector
PSL440	Asymmetric deg	Streetligh...	94 %	0.460	-
PSL445	Asymmetric deg	Streetligh...	94 %	0.370	-
XHP50	Asymmetric deg	Streetligh...	89 %	0.420	-
XHP70	Asymmetric deg	Streetligh...	94 %	0.380	-
XHP35 HD	Asym deg	Streetligh...	94 %	0.480	-
XHP35 HI	Asymmetric deg	Streetligh...	94 %	0.490	-
LUXEON M/MX	Asymmetric deg	Streetligh...	94 %	0.450	-
LUXEON MZ	Asymmetric deg	Streetligh...	94 %	0.500	-
LUXEON XR-M square 2x2	Asymmetric deg	Streetligh...	94 %	0.450	-
NV4x144A	Asymmetric deg	Streetligh...	94 %	0.455	-
NFMW48xA	sim: Asym	Streetligh...	sim: 94 %	sim: 0.480	-
Duris S10	sim: Asymmetri	Streetligh...	sim: 93 %	-	-
Duris P10	sim: Asymmetri	Streetligh...	sim: 92 %	sim: 0.420	-

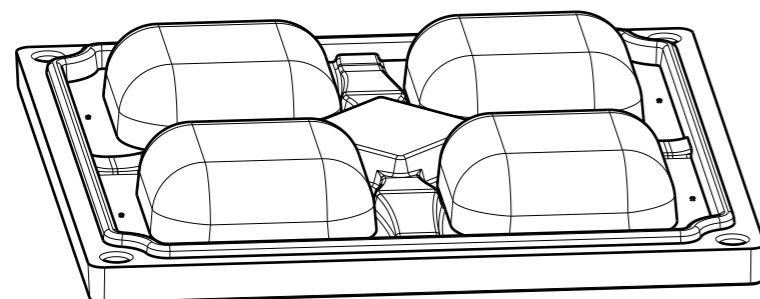
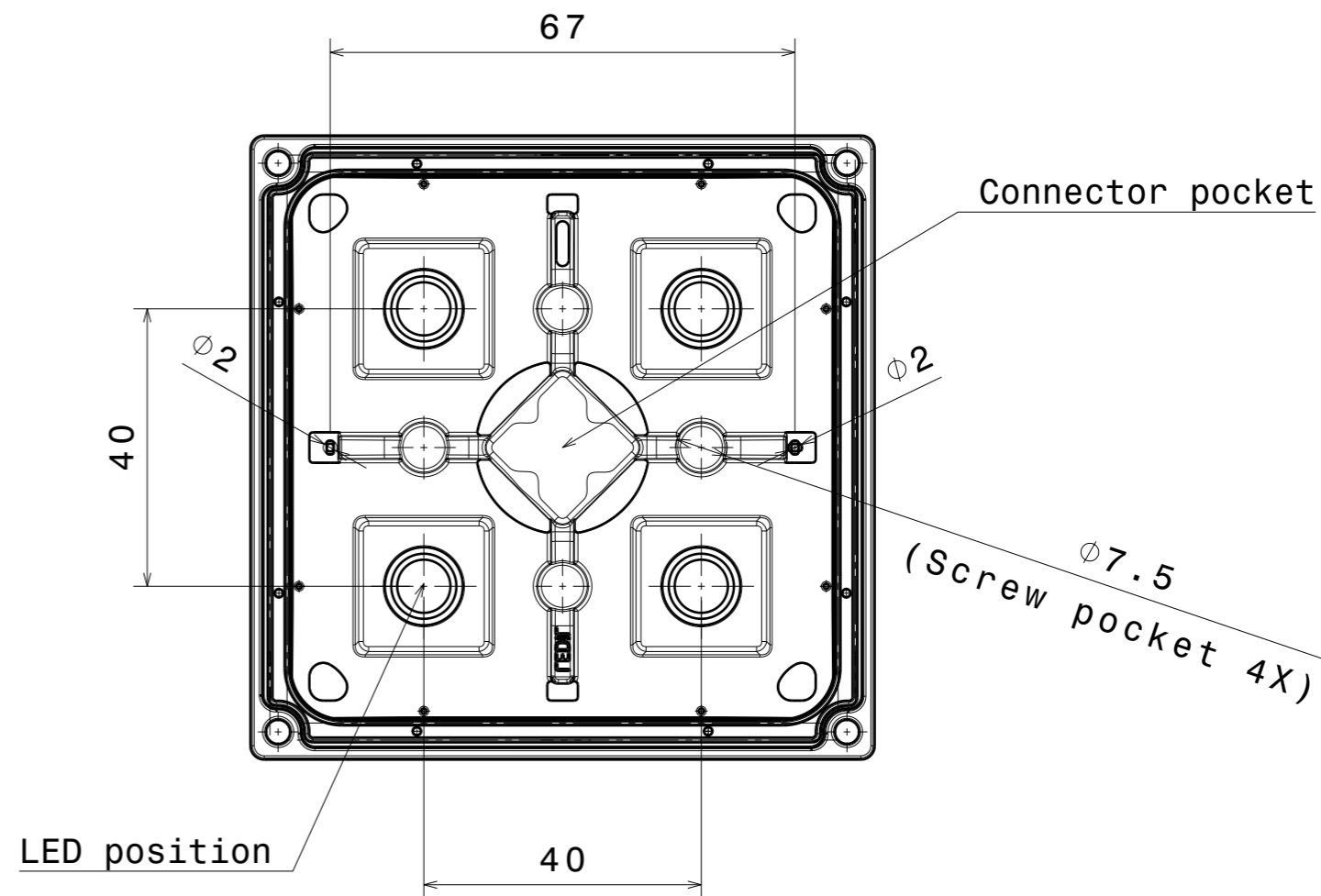
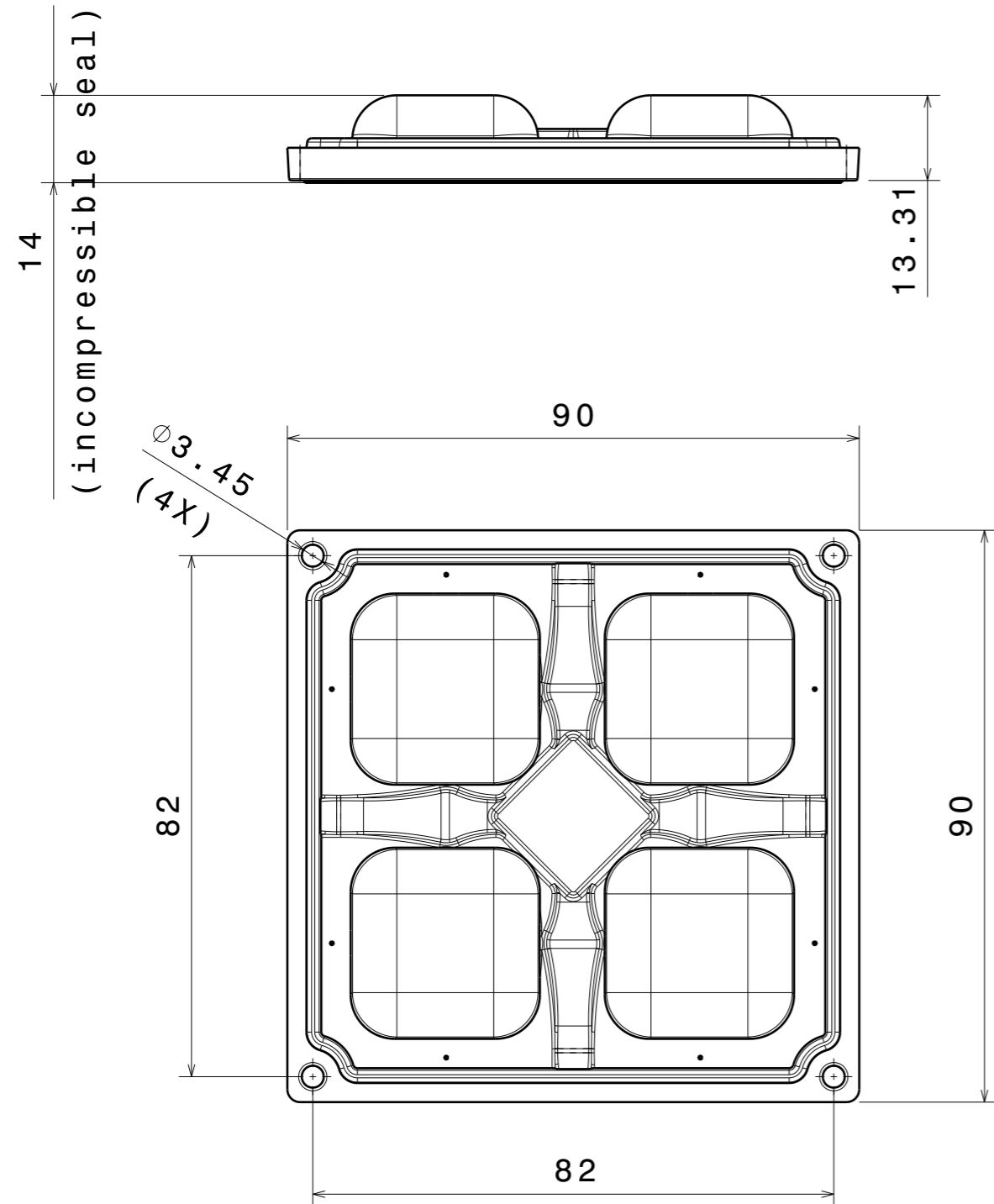

Isometric view (1:1)

INDEX	PART NO	DESCRIPTION	MATERIAL	COLOUR
1	C14631	STRADA-2X2MX-SEAL	silicone	
2	C14763	STRADA-2X2MX-VSM	PMMA	

Tolerances if not otherwise shown
 According to DIN ISO 2768-1
 Linear measures:
 up to 30mm class M, otherwise class C
 According to DIN ISO 2768-2
 Form and position: class L



Ledil Oy
 Salorankatu 10
 FIN 24240 SALO
 Finland

THIRD ANGLE PROJECTION:

DRAWING TITLE
CS14764_STRADA-2X2MX-VSM

This drawing is the property
 of LEDiL Oy. It may not be
 reproduced, copied or
 communicated without a written
 agreement with LEDiL Oy.

SIZE	PART NUMBER	
A3	CS14764	
SCALE	1:1	WEIGHT 48.4 g
SHEET		1/1

Luminaire: LEDiL Oy CS14764_STRADA-2X2MX-VSM_(PSL440)_GS
Lamps: 1 x Citizen_PSL440_1034.87lm@250mA_P=11.3823W_I=0.250A

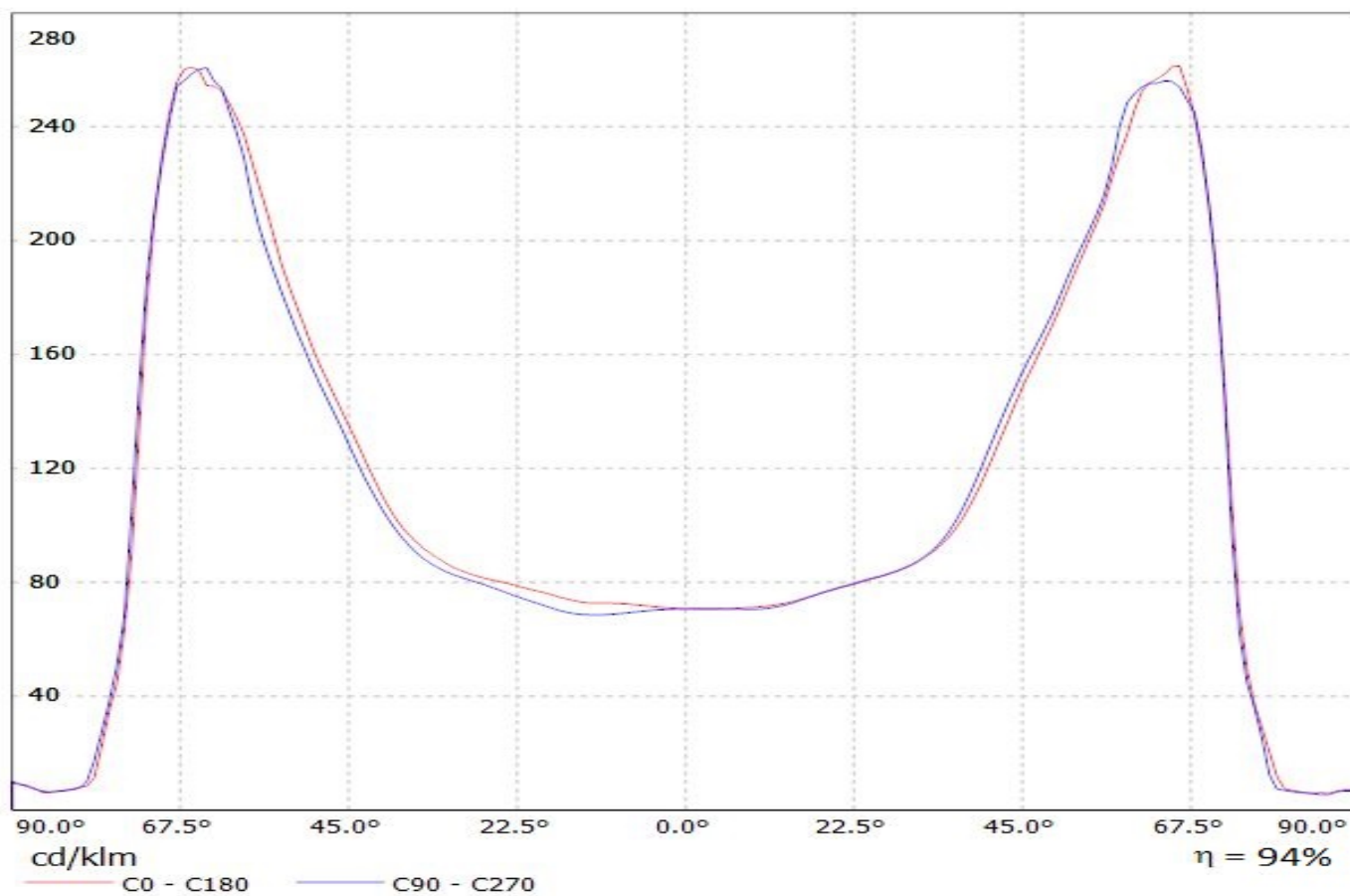

Luminaire: LEDiL Oy CS14764_STRADA-2X2MX-VSM_(PSL445)
Lamps: 1 x Citizen_PSL445_2x2_1674.9lm@250mA_P=11.1421W_I=0.250A_CCT=2700K

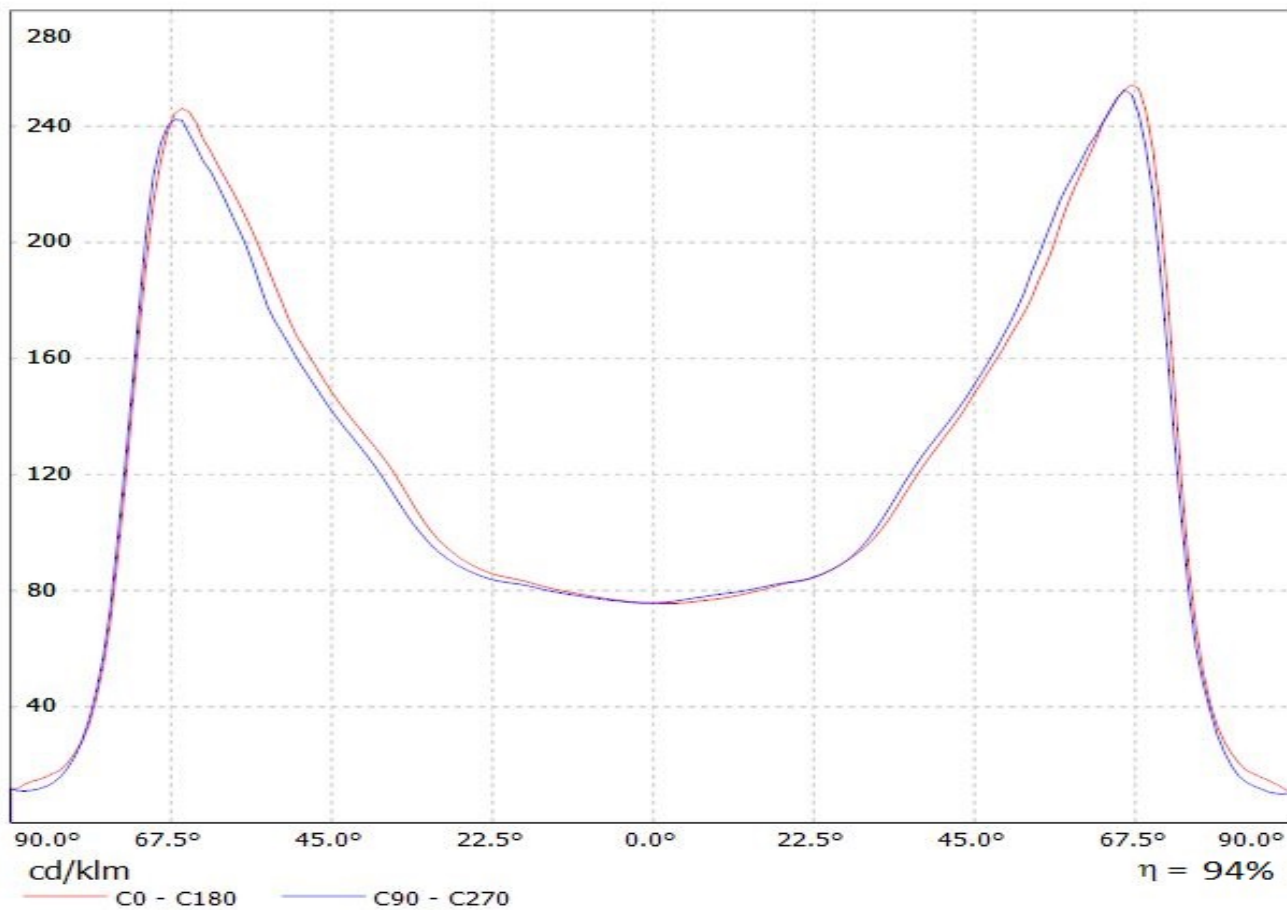

Luminaire: LEDiL Oy C14763_STRADA-2x2MX-VSM_(XHP50)

Lamps: 1 x Cree_XHP50_(XHP50-0-1B0-J20-D0-B-01)_1815.16lm@250mA_P=11.4001W_I=0.250A

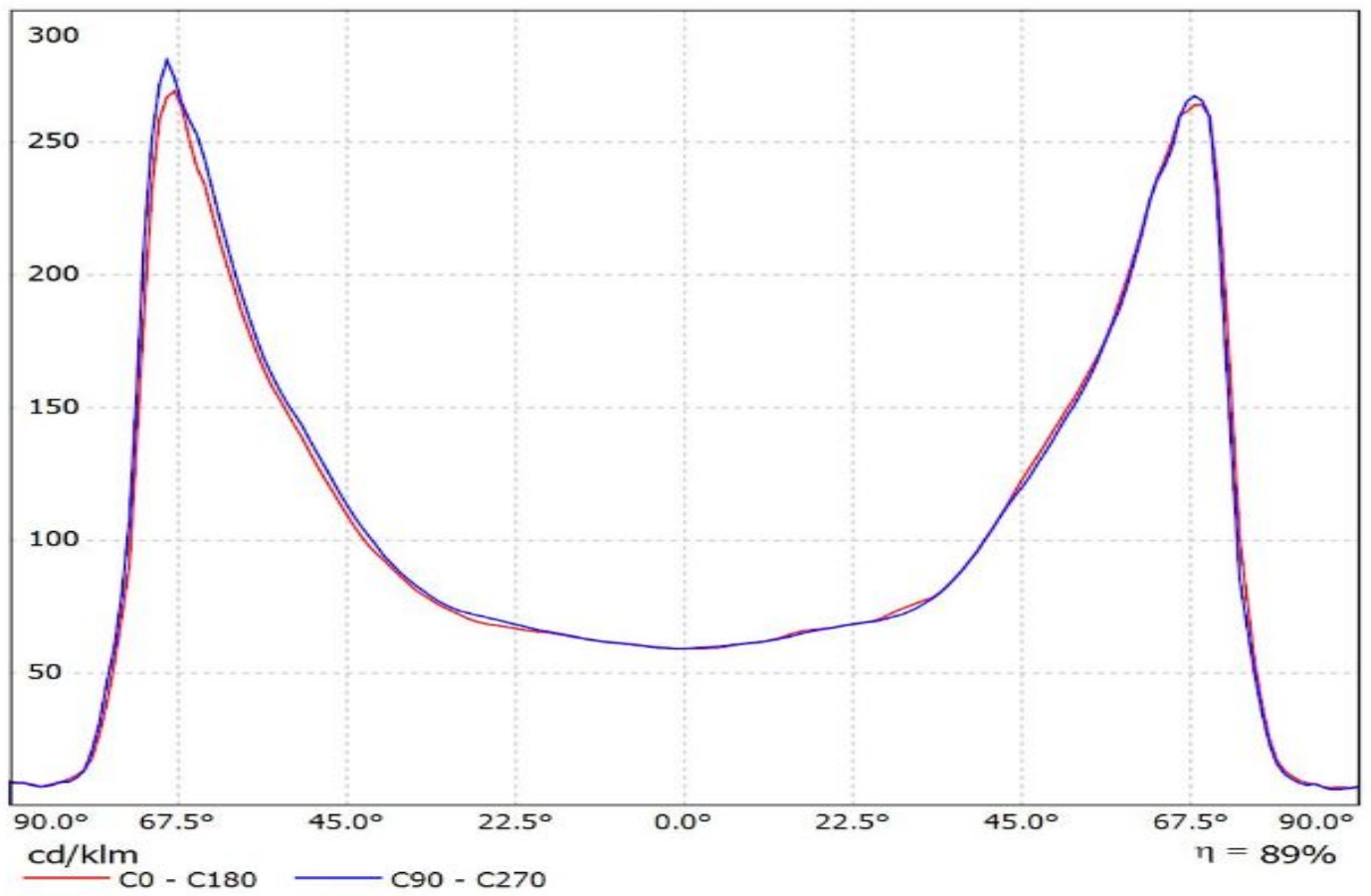

Ledil CS14764_STRADA-2X2MX-VSM_(XHP70) / LDC (Linear)

Luminaire: Ledil CS14764_STRADA-2X2MX-VSM_(XHP70)

Lamps: 1 x Cree_XHP70-2x2MX_1527.15lm@250mA_P=10.997W_I=0.25A

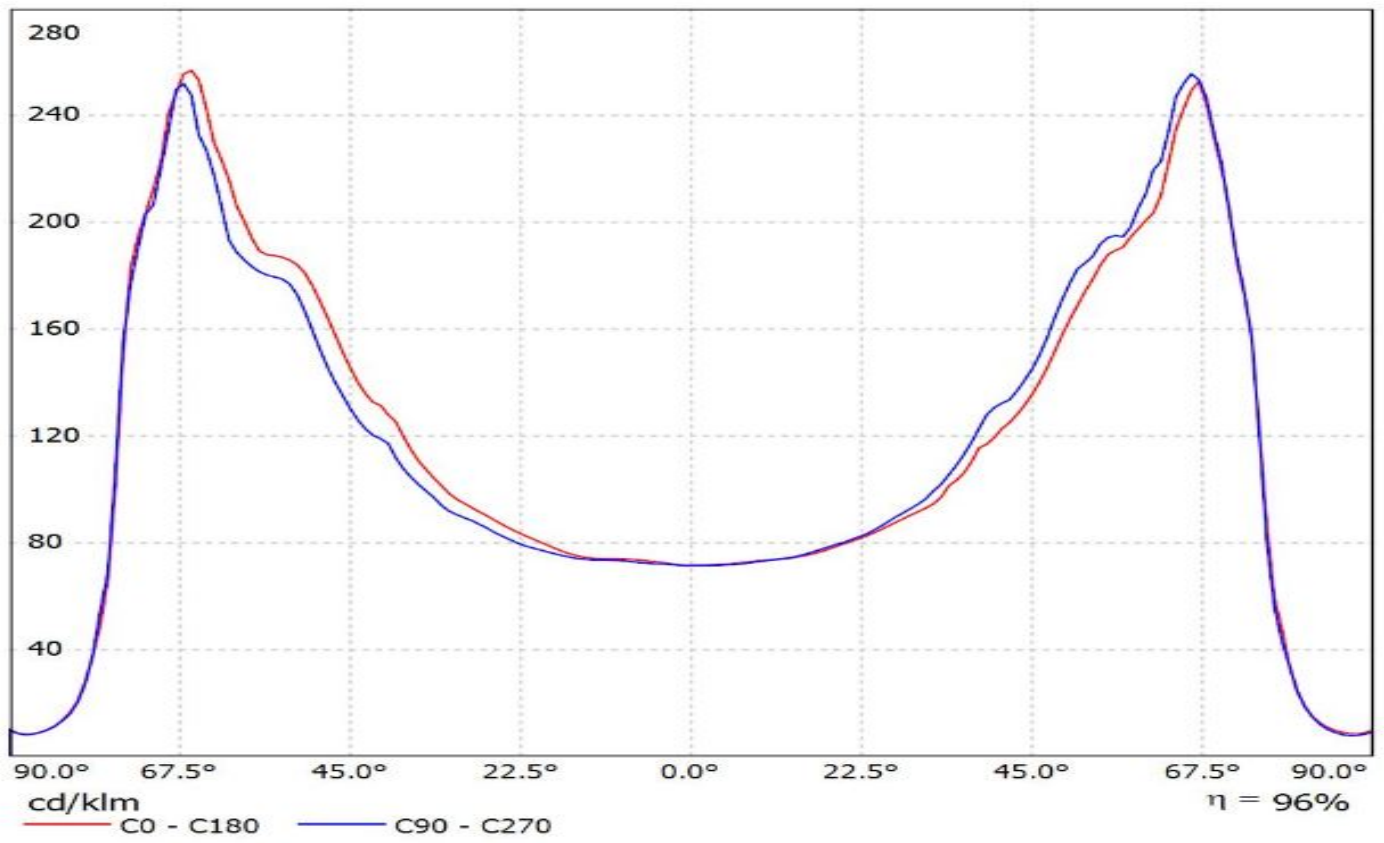

Luminaire: LEDiL Oy CS14764_STRADA-2X2MX-VSM_(XHP35_HD)

Lamps: 1 x Cree_XHP35_HD_(XHP35A-0-2D0-D40-D0-B-01)_1728.98lm@250mA_P=11.3112W_I=0.250A

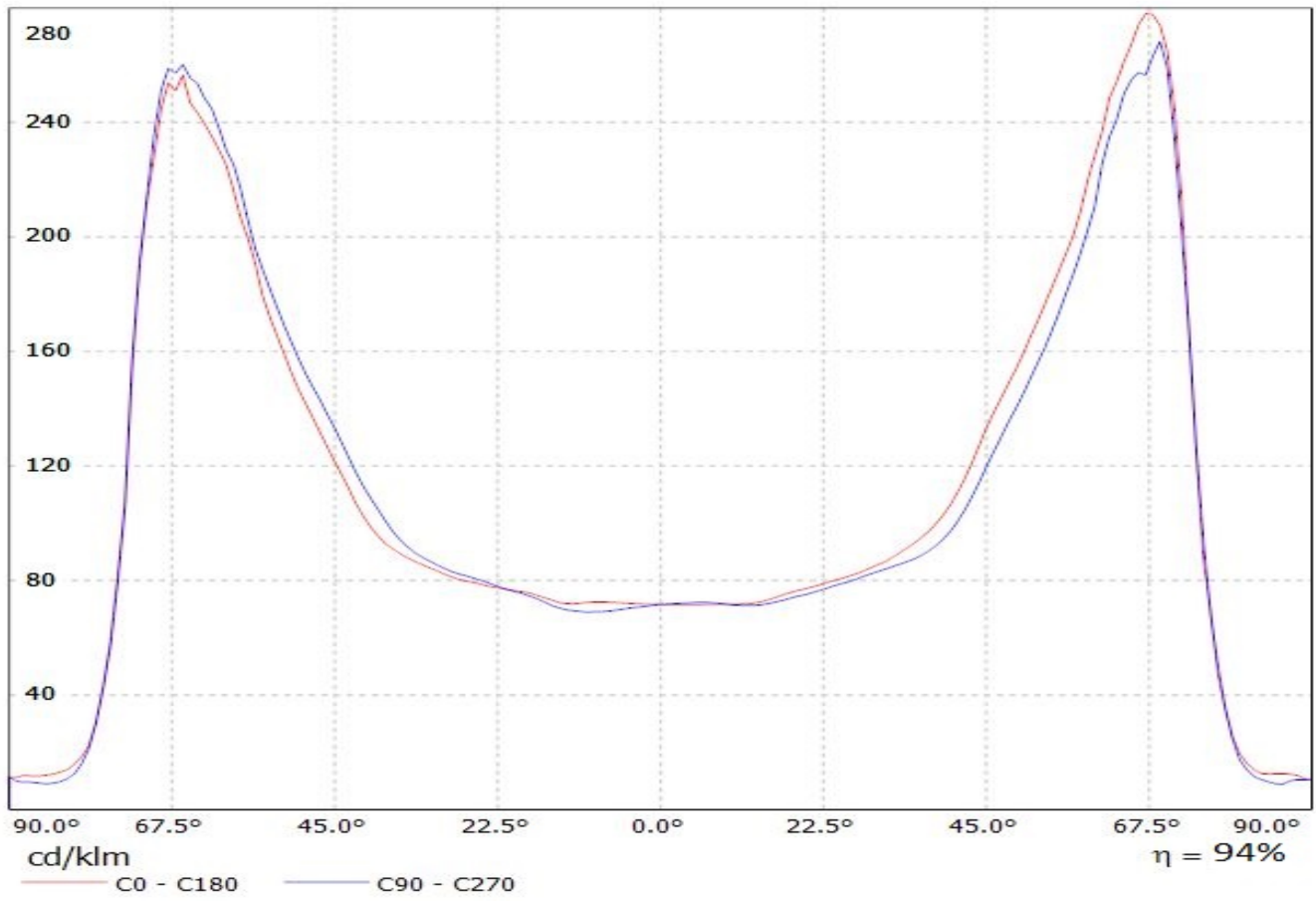

Luminaire: LEDiL Oy CS14764_STRADA-2X2MX-VSM (XHP35_HI)
Lamps: 1 x Cree_XHP35_HI (XHP35A-H-5C0-D40-D0-B-01)_1615.75lm@250mA_CCT=4000K_P=11.4373W_I=0.250A

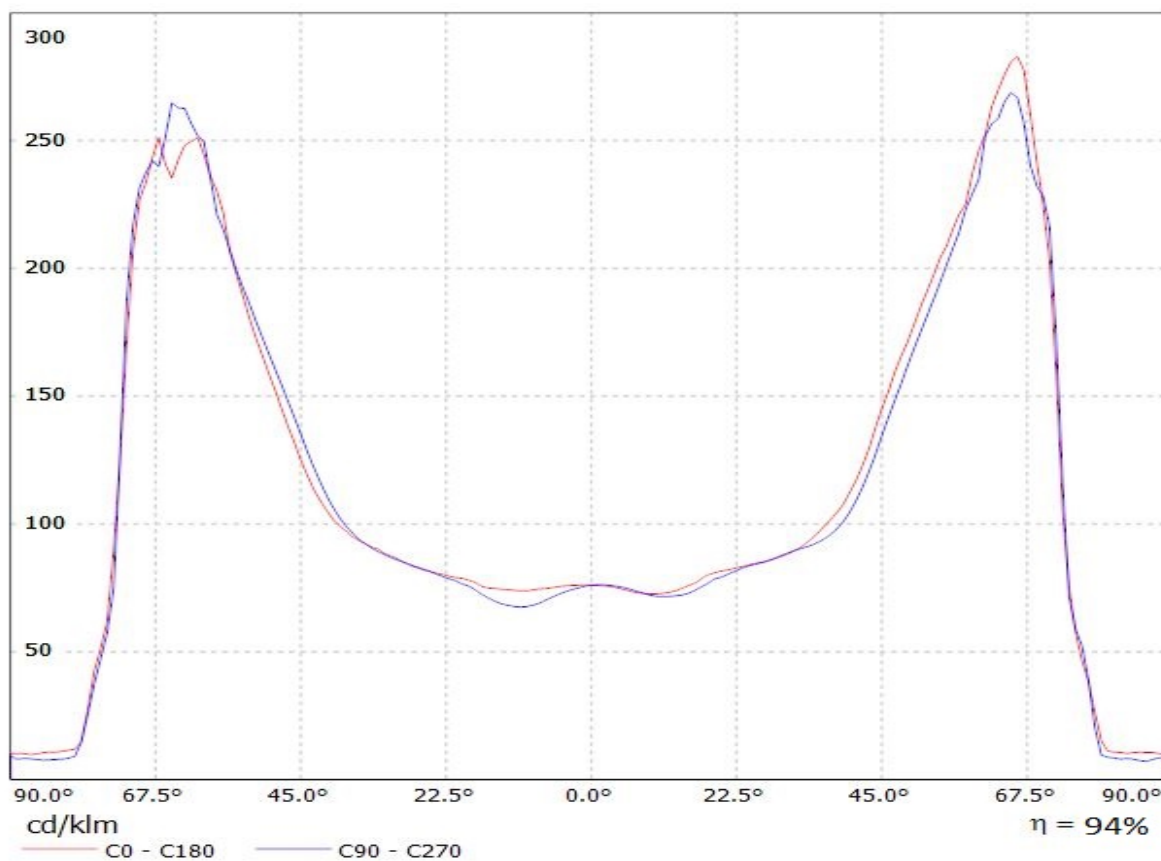

Ledil CS14764_STRADA-2X2MX-VSM_(Luxeon_M) / LDC (Linear)

Luminaire: Ledil CS14764_STRADA-2X2MX-VSM_(Luxeon_M)

Lamps: 1 x Luxeon_M_2x2MX_(Lumileds)_1799.33lm@250mA_P=10.874W_I=0.25A

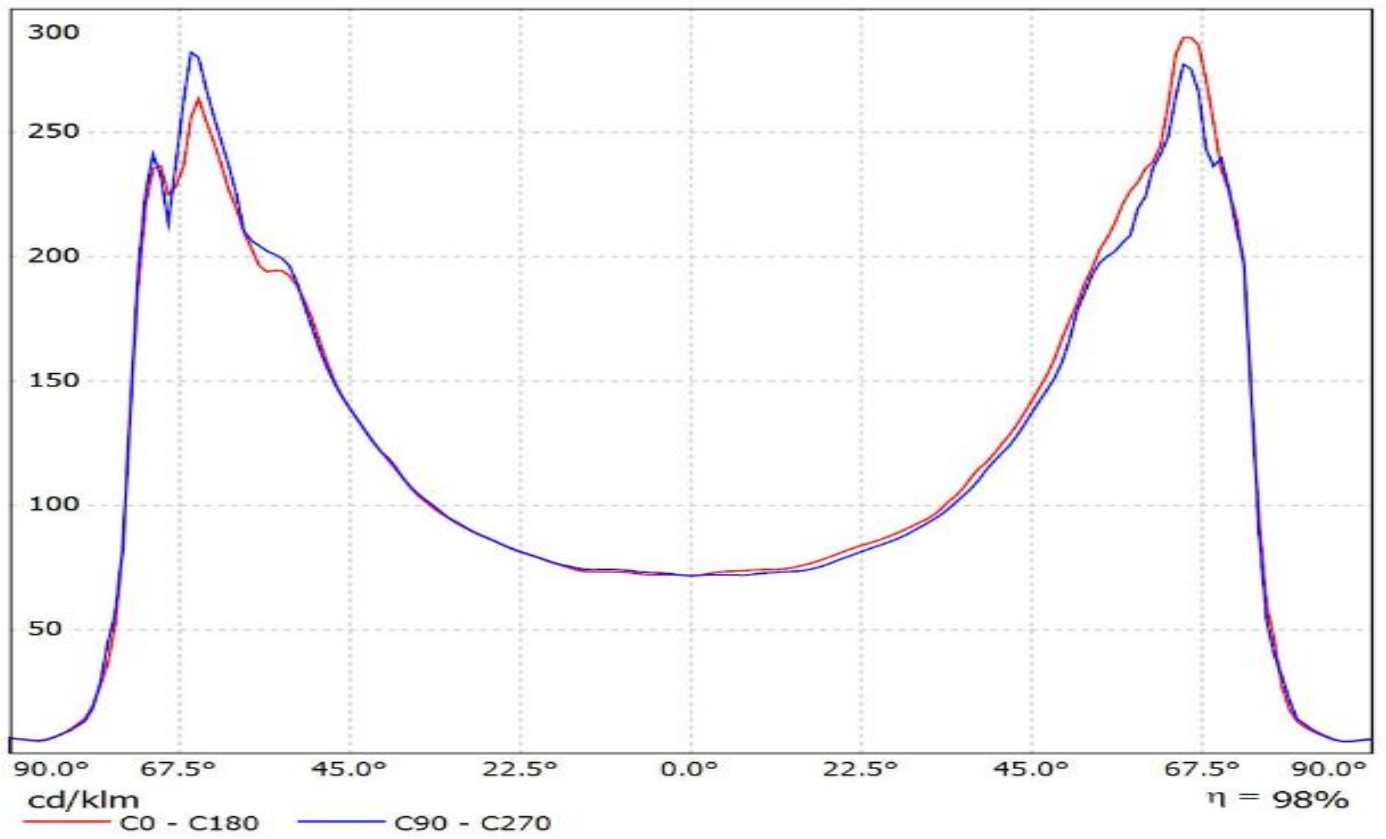

Ledil CS14764_STRADA-2X2MX-VSM_(Luxeon_MZ) / LDC (Linear)

Luminaire: Ledil CS14764_STRADA-2X2MX-VSM_(Luxeon_MZ)

Lamps: 1 x Luxeon_MZ-2x2MX_(LMZ9-SW30)_1123.93lm@250mA_CCT=3000K_P=10.967W_I=0.25A

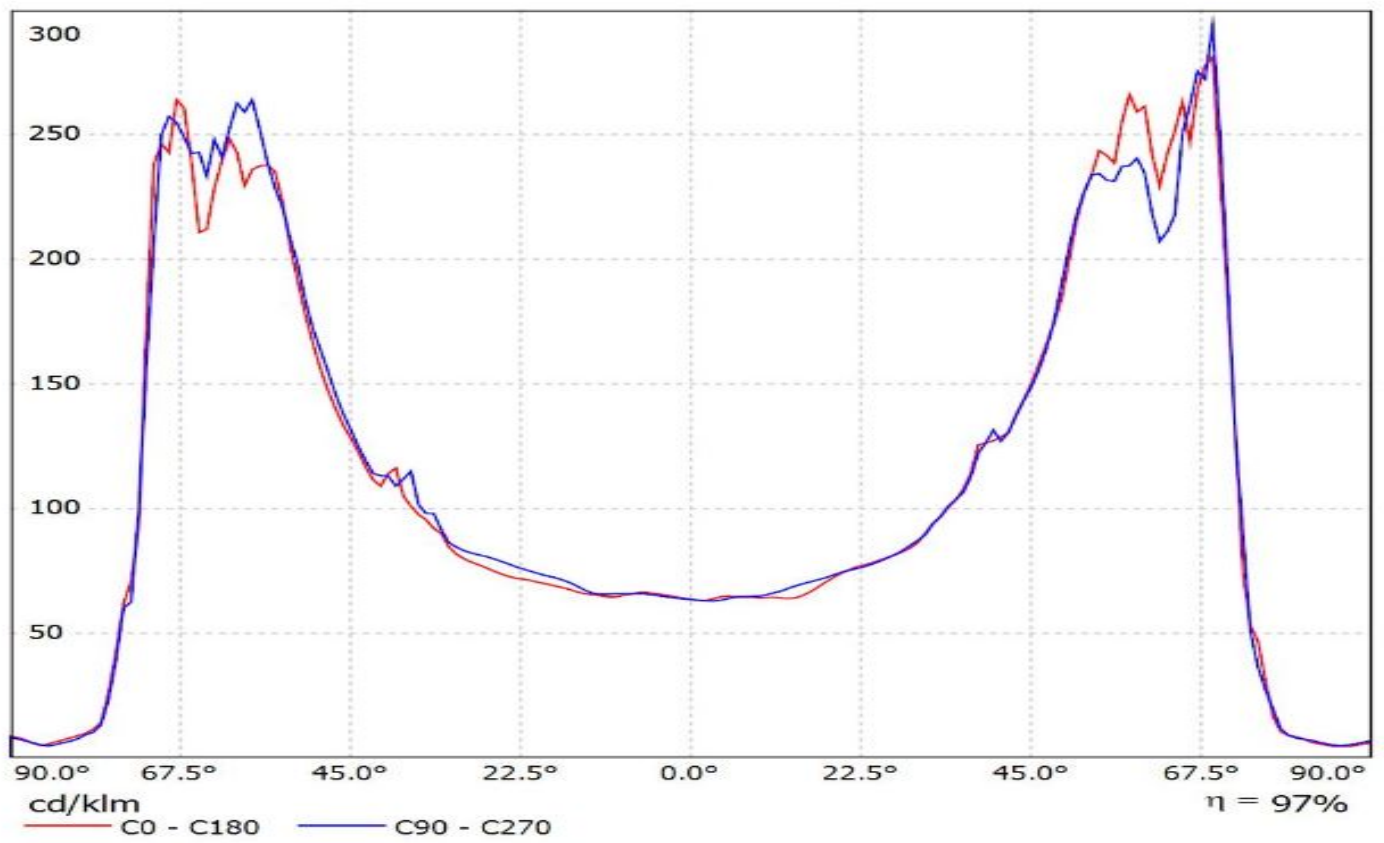

Luminaire: Ledil CS14764_STRADA-2X2MX-VSM_(XR-M_2x2)
Lamps: 1 x XR-M_2x2_1799.33lm@250mA_P=10.874W_η=0.25A

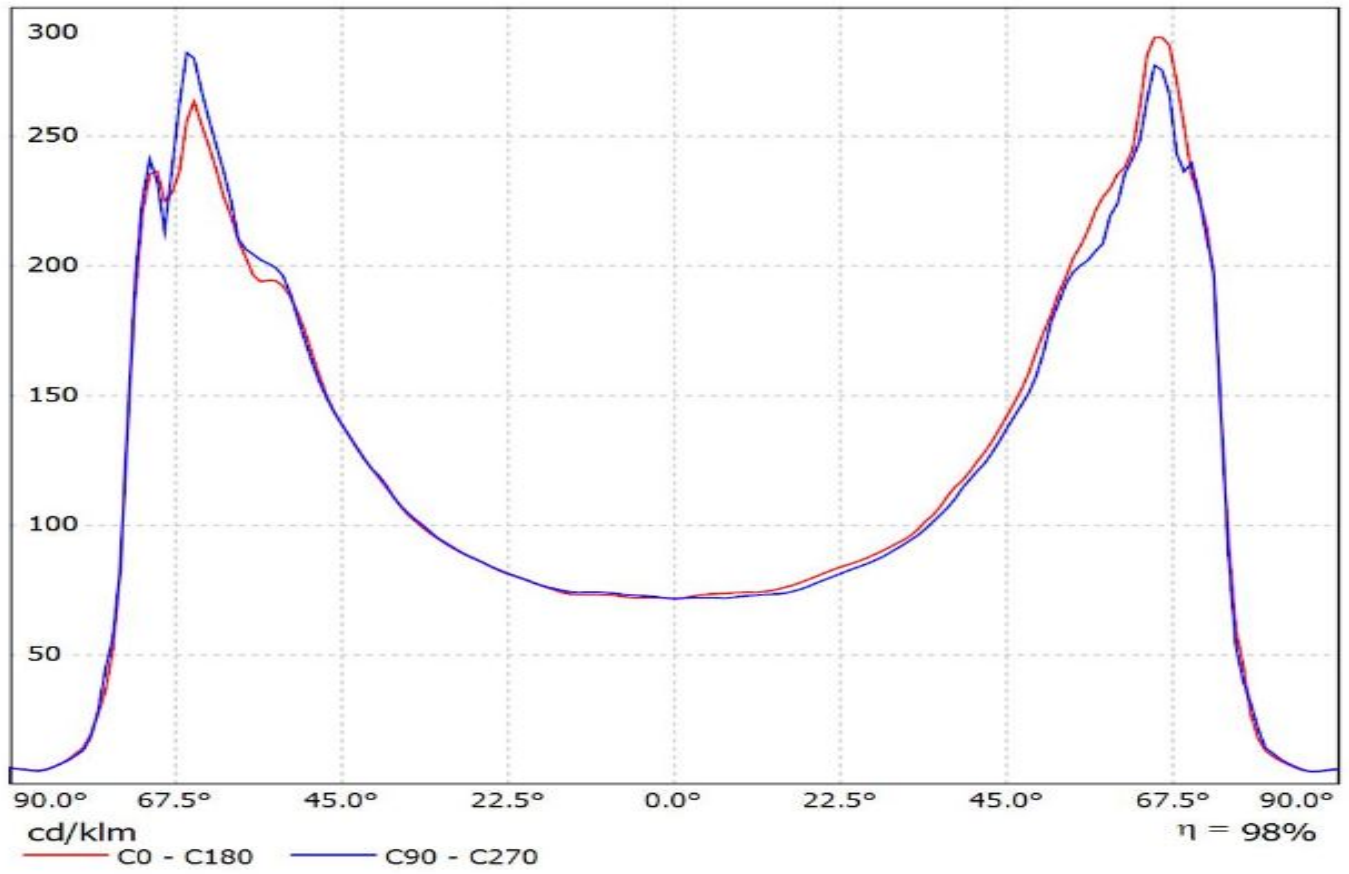

Luminaire: LEDiL Oy CS14764_STRADA-2X2MX-VSM_(NV4x144A)
Lamps: 1 x Nichia_NV4x144A_1841.22lm@250mA_P=10.9615W_I=0.250A

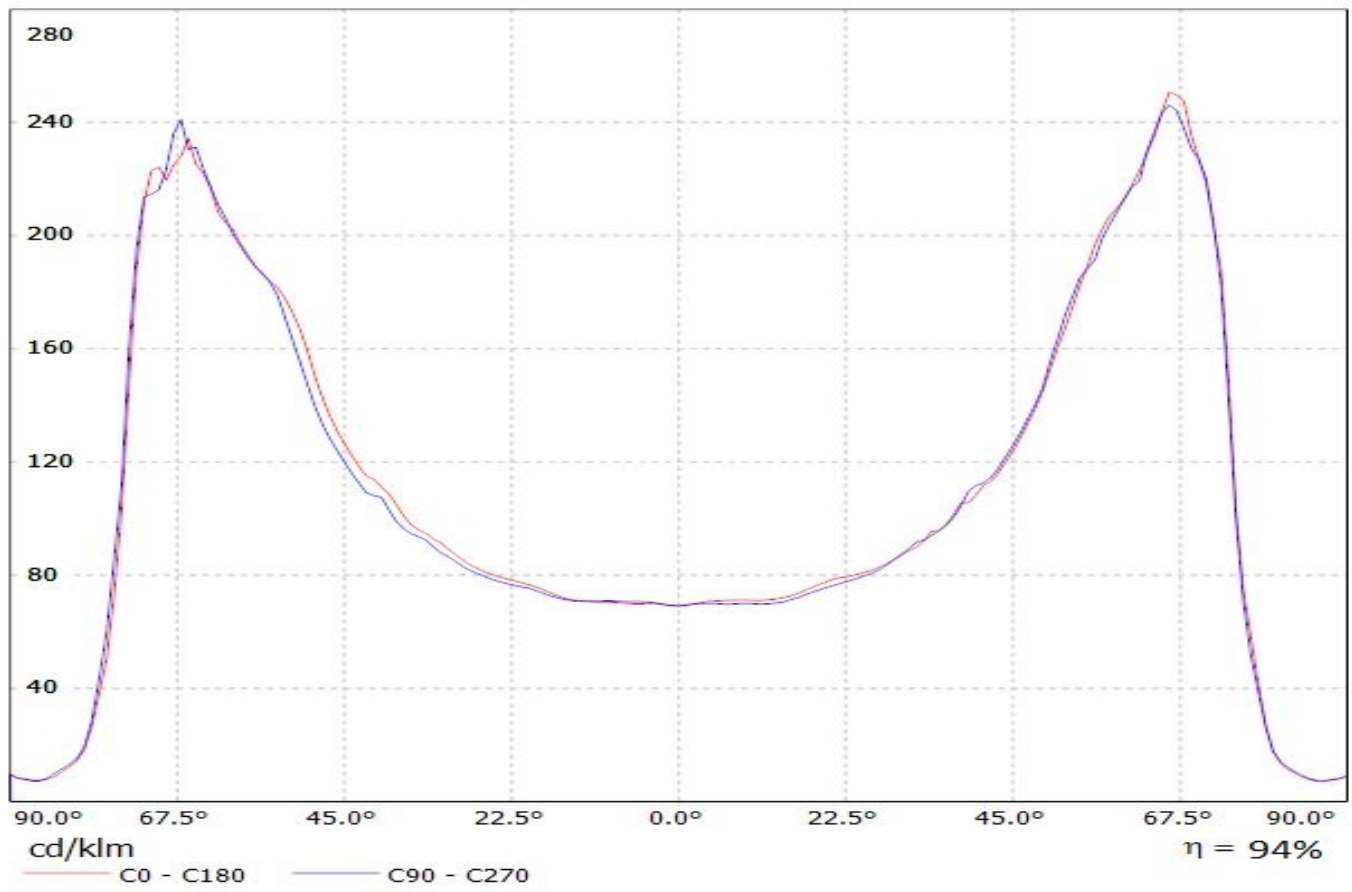

Luminaire: LEDiL Oy CS14764_STRADA-2X2MX-VSM_(PSL440)_GS
Lamps: 1 x Citizen_PSL440_1034.87lm@250mA_P=11.3823W_I=0.250A

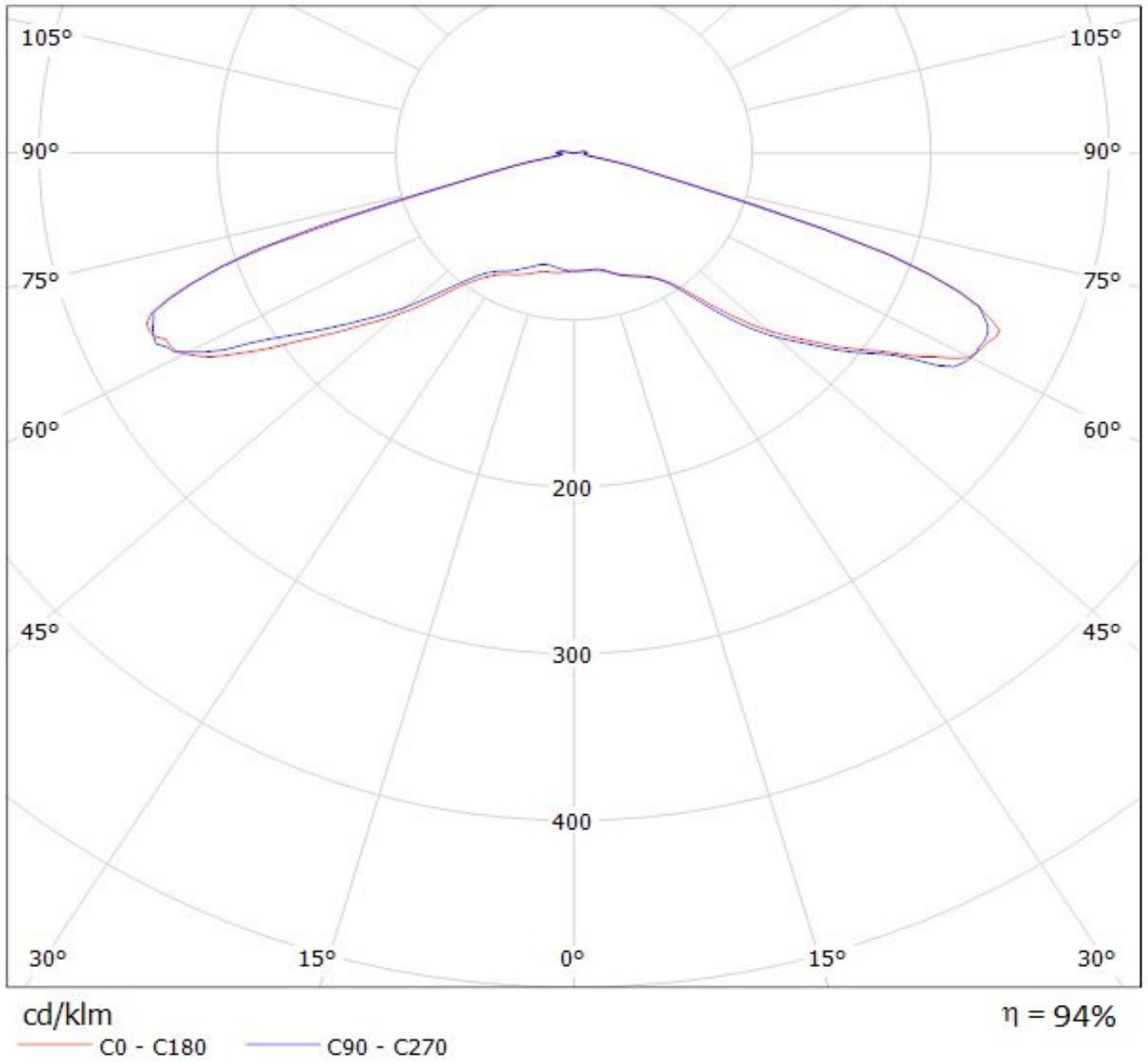

Luminaire: LEDiL Oy CS14764_STRADA-2X2MX-VSM_(PSL445)

Lamps: 1 x Citizen_PSL445_2x2_1674.9lm@250mA_P=11.1421W_I=0.250A_CCT=2700K

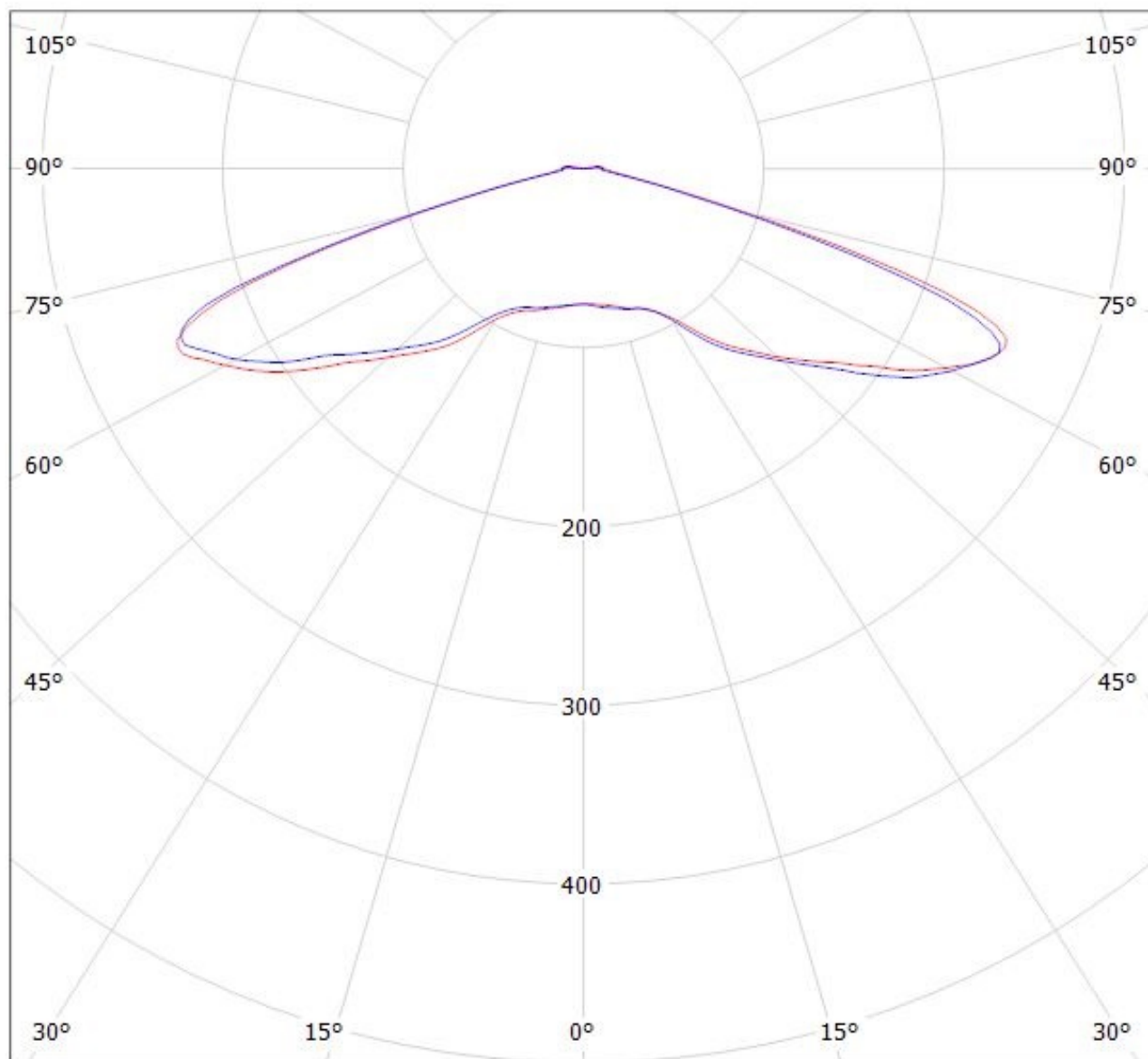

cd/klm

— C0 - C180

— C90 - C270

$\eta = 94\%$

Luminaire: LEDiL Oy C14763_STRADA-2x2MX-VSM_(XHP50)

Lamps: 1 x Cree_XHP50_(XHP50-0-1B0-J20-D0-B-01)_1815.16lm@250mA_P=11.4001W_I=0.250A

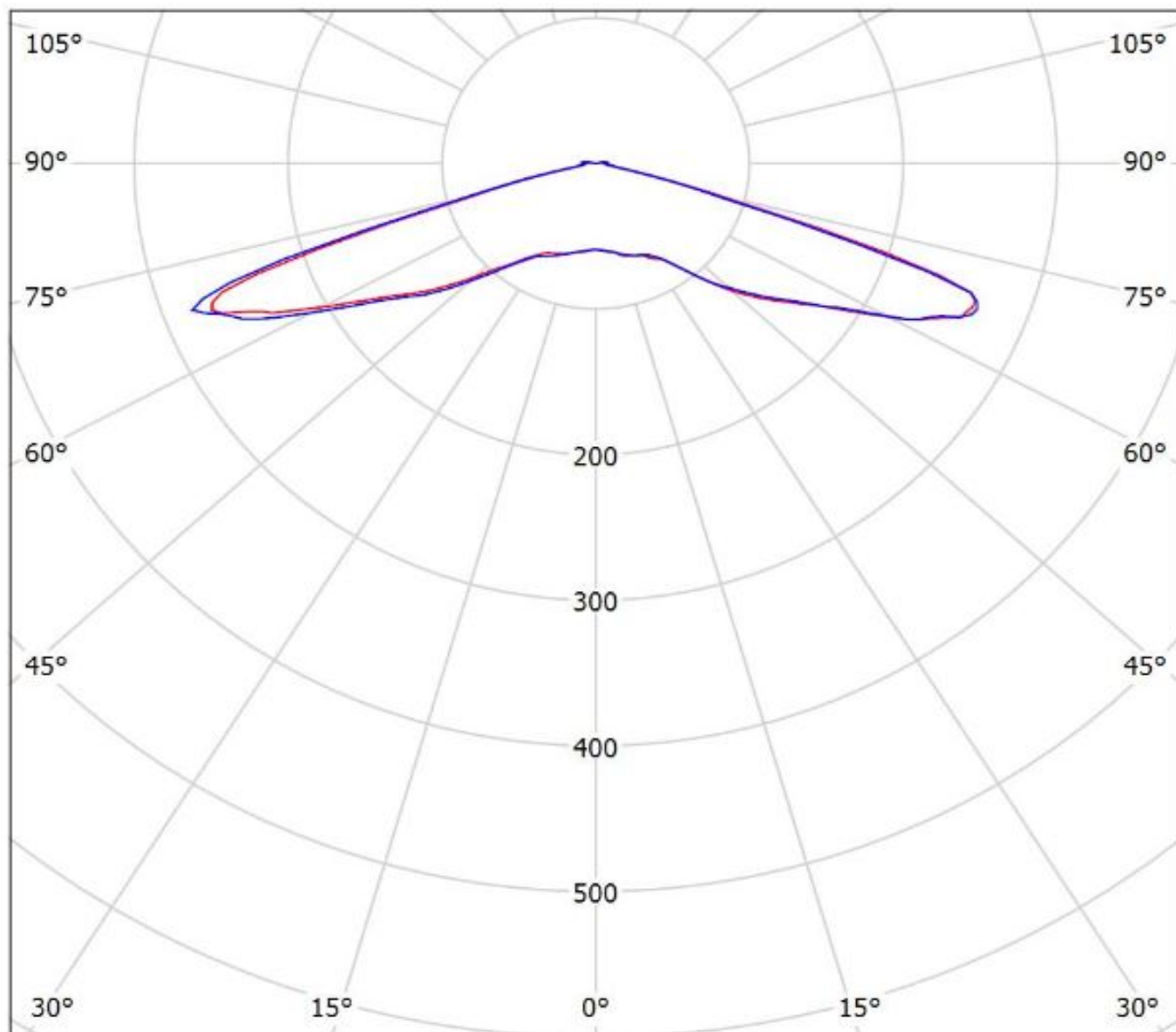

cd/klm

— C0 - C180

— C90 - C270

$\eta = 89\%$

Ledil CS14764_STRADA-2X2MX-VSM_(XHP70) / LDC (Polar)

Luminaire: Ledil CS14764_STRADA-2X2MX-VSM_(XHP70)

Lamps: 1 x Cree_XHP70-2x2MX_1527.15lm@250mA_P=10.997W_I=0.25A

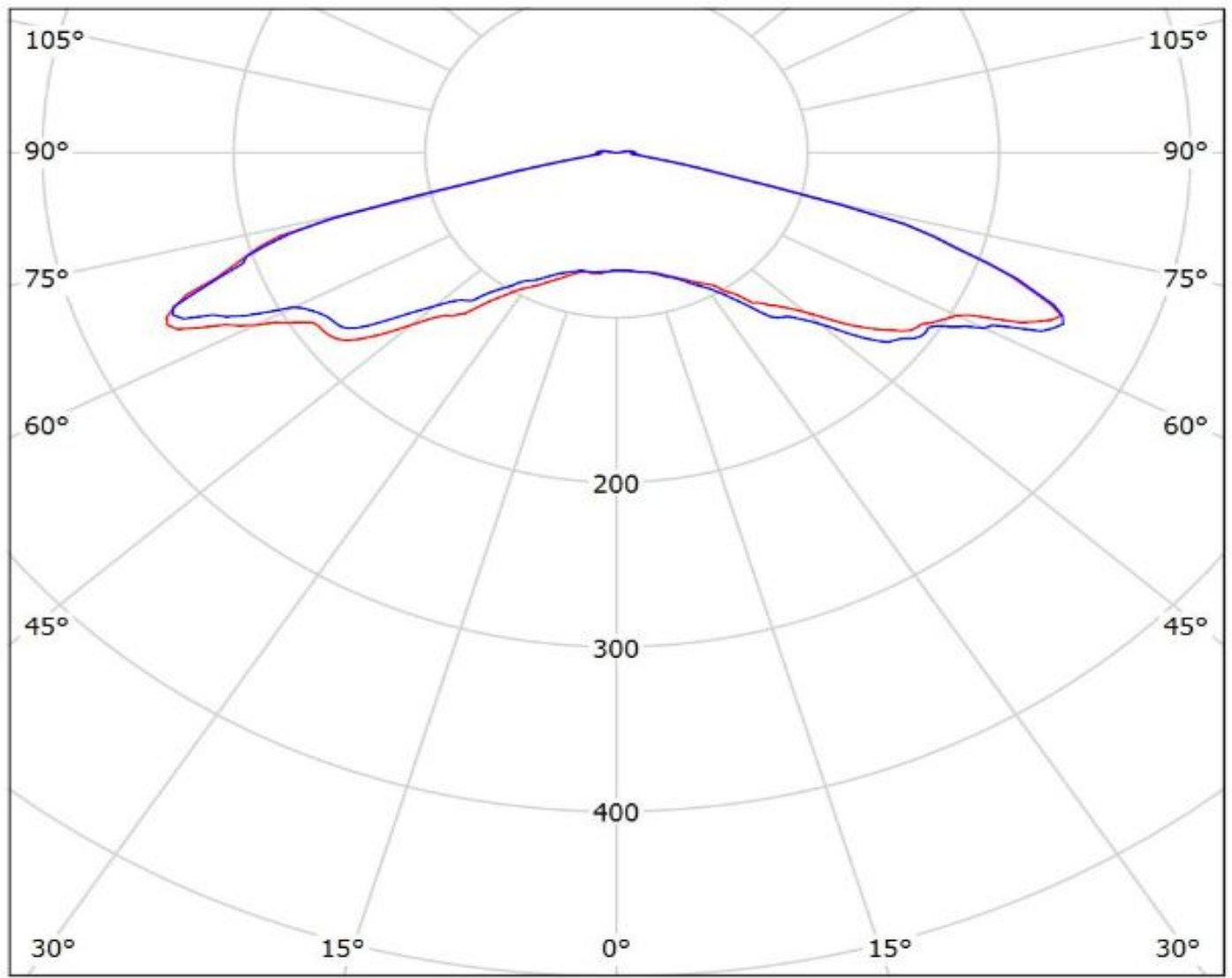

cd/klm

— C0 - C180

— C90 - C270

$\eta = 96\%$

Luminaire: LEDiL Oy CS14764_STRADA-2X2MX-VSM_(XHP35_HD)

Lamps: 1 x Cree_XHP35_HD_(XHP35A-0-2D0-D40-D0-B-01)_1728.98lm@250mA_P=11.3112W_I=0.250A

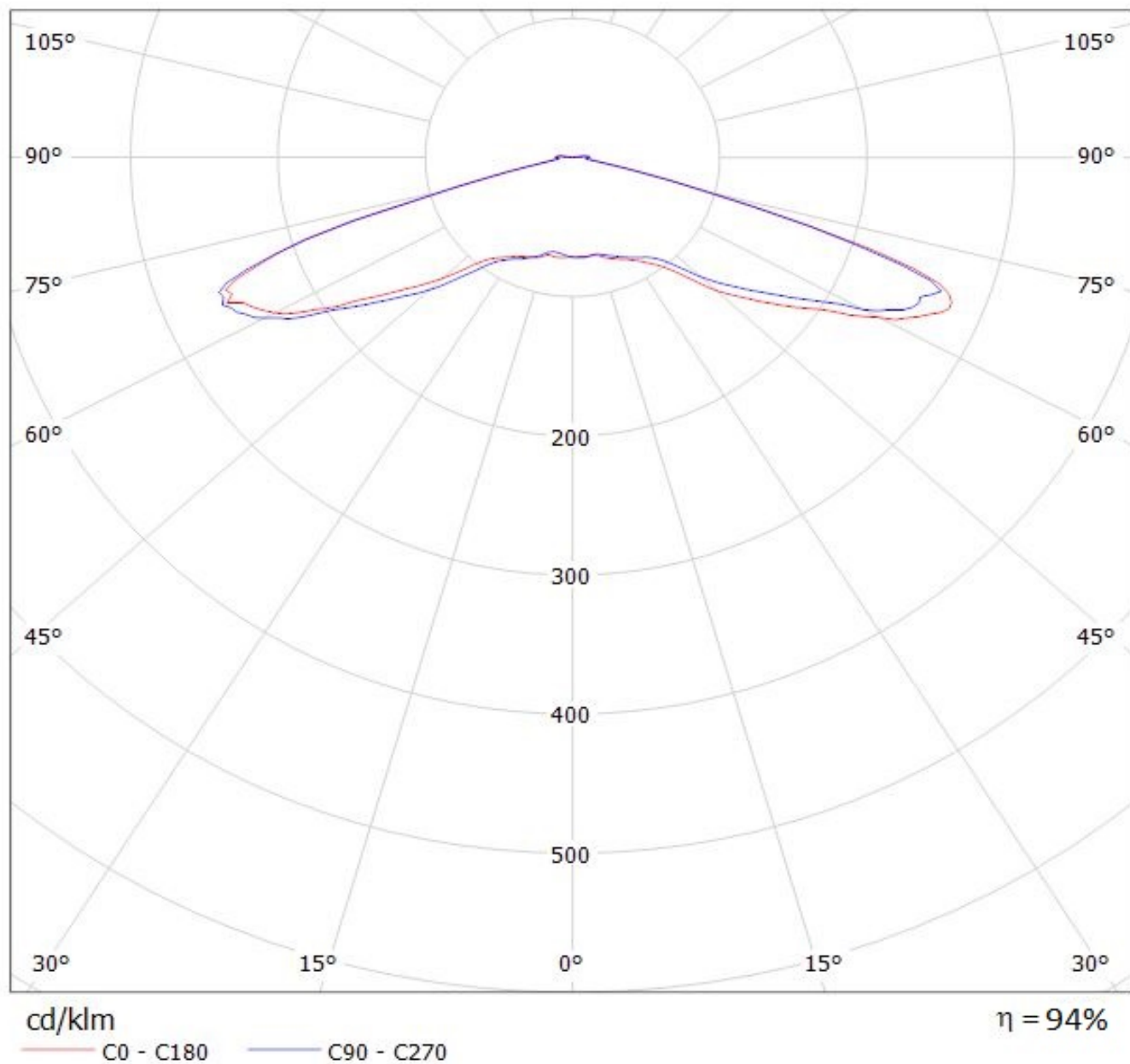

Luminaire: LEDiL Oy CS14764_STRADA-2X2MX-VSM (XHP35_HI)

Lamps: 1 x Cree_XHP35_HI (XHP35A-H-5C0-D40-D0-B-01)_1615.75lm@250mA_CCT=4000K_P=11.4373W_I=0.250A

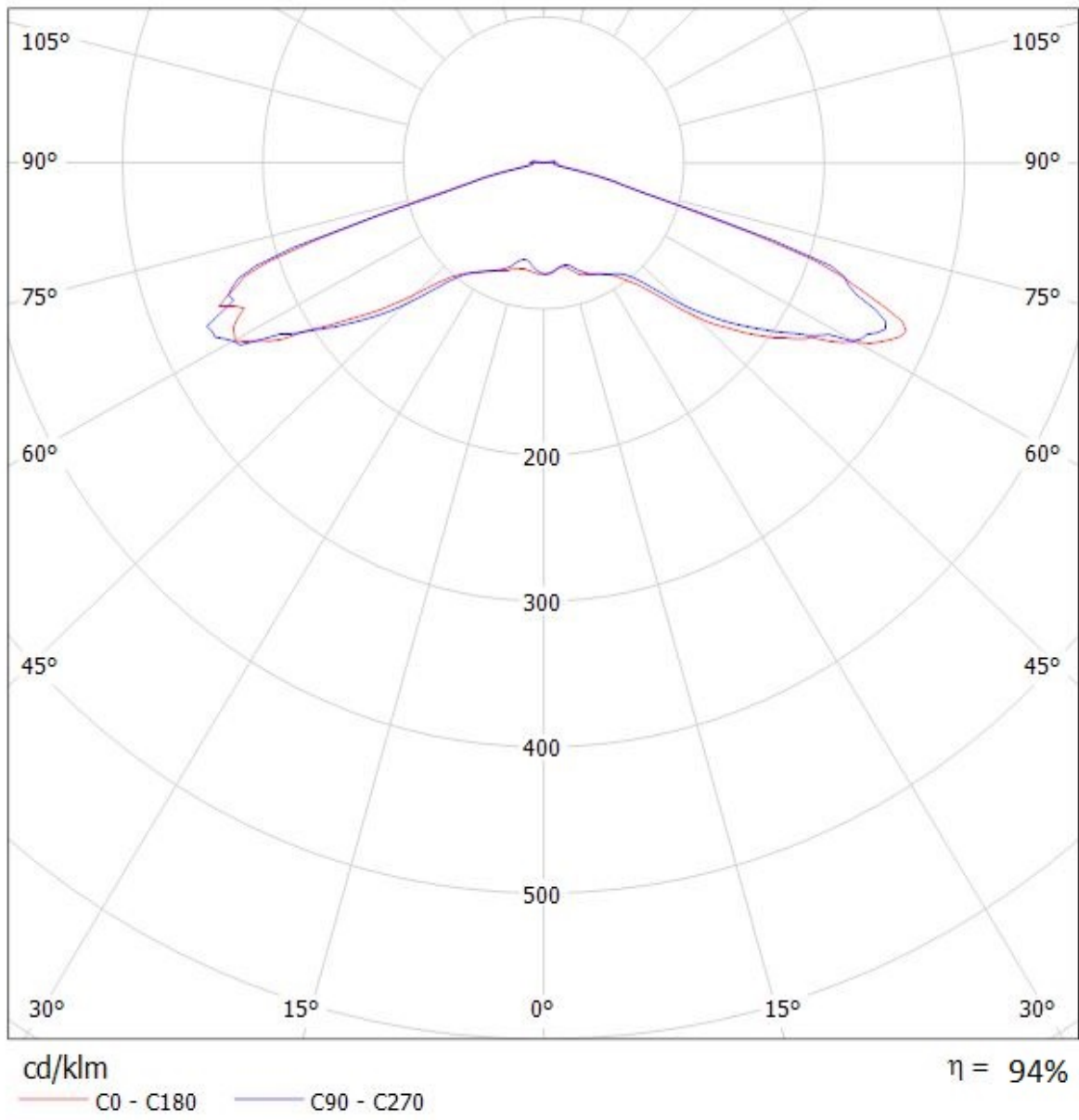

Ledil CS14764_STRADA-2X2MX-VSM_(Luxeon_M) / LDC (Polar)

Luminaire: Ledil CS14764_STRADA-2X2MX-VSM_(Luxeon_M)

Lamps: 1 x Luxeon_M_2x2MX_(Lumileds)_1799.33lm@250mA_P=10.874W_I=0.25A

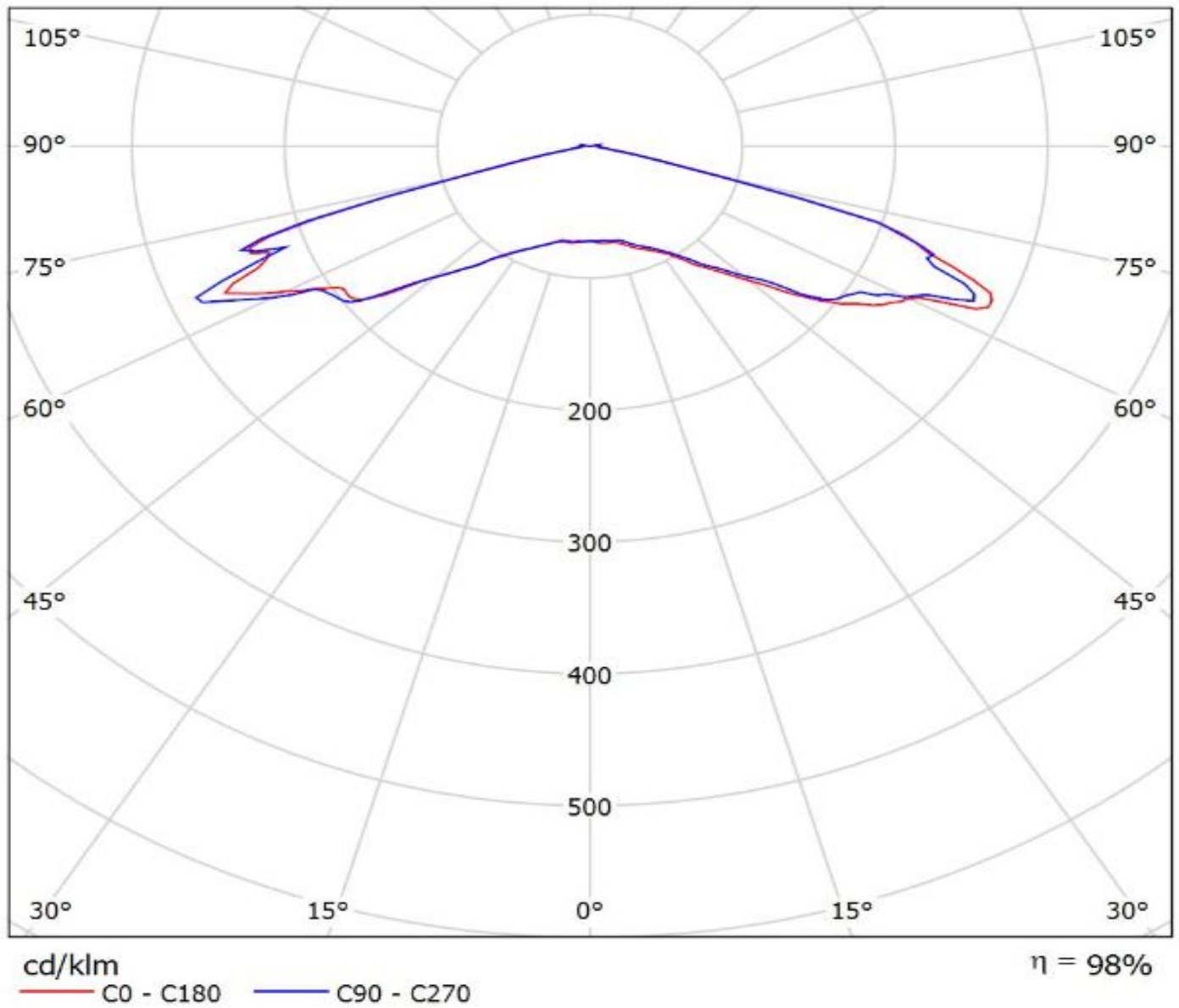

Ledil CS14764_STRADA-2X2MX-VSM_(Luxeon_MZ) / LDC (Polar)

Luminaire: Ledil CS14764_STRADA-2X2MX-VSM_(Luxeon_MZ)

Lamps: 1 x Luxeon_MZ-2x2MX_(LMZ9-SW30)_1123.93lm@250mA_CCT=3000K_P=10.967W_I=0.25A

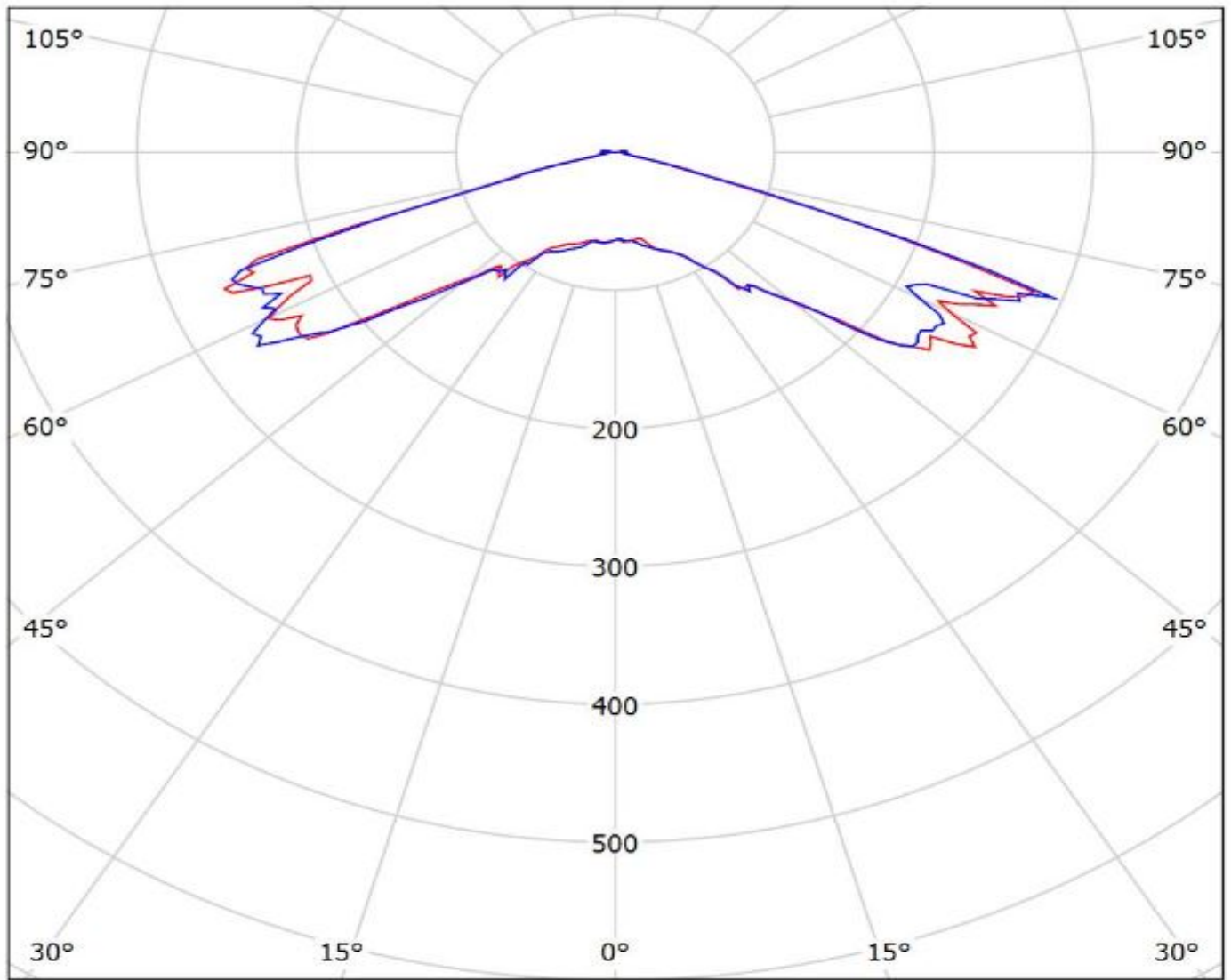

cd/klm

— C0 - C180 — C90 - C270

$\eta = 97\%$

Luminaire: Ledil CS14764_STRADA-2X2MX-VSM_(XR-M_2x2)
Lamps: 1 x XR-M_2x2_1799.33lm@250mA_P=10.874W_I=0.25A

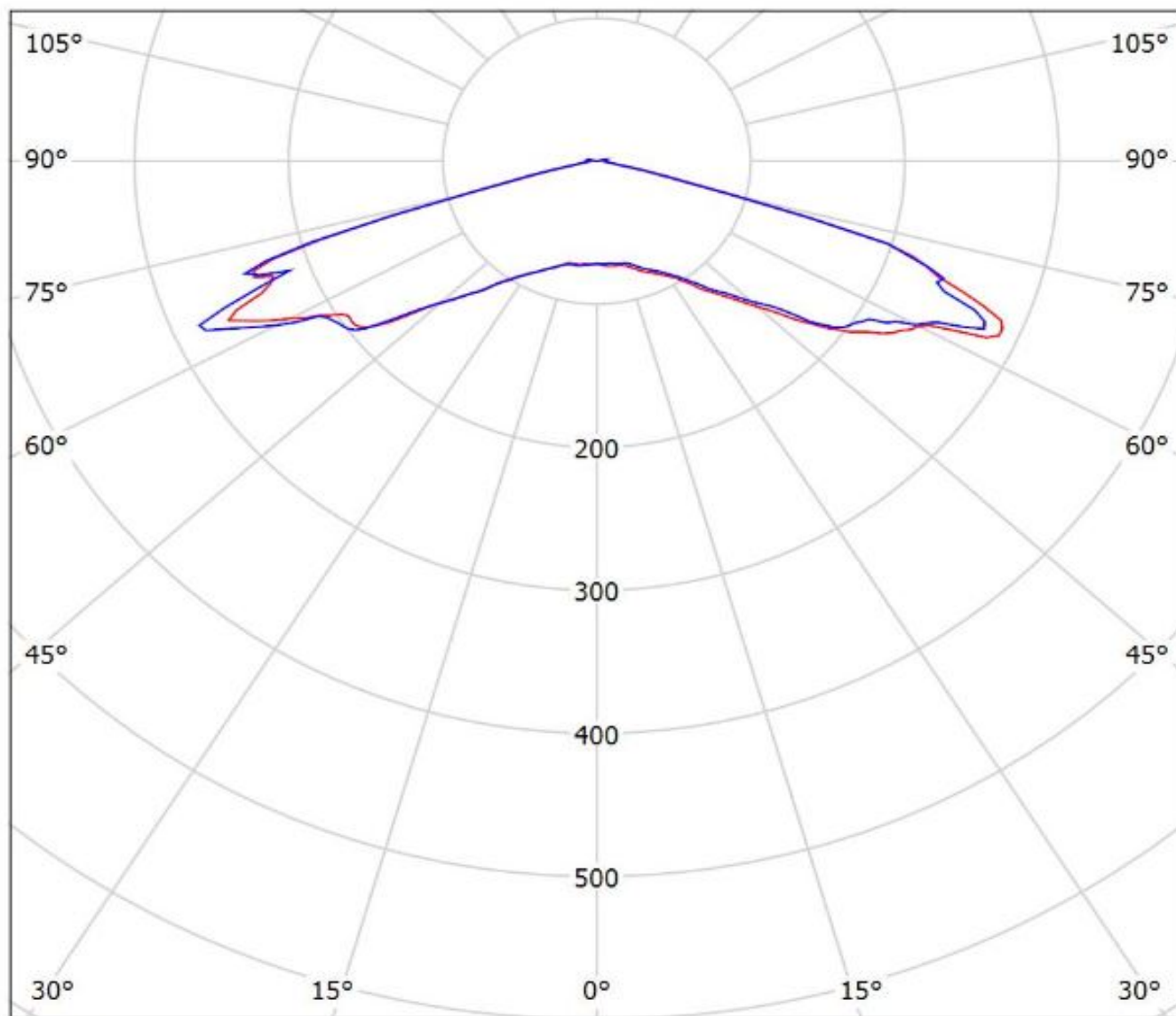

cd/klm
— C0 - C180 — C90 - C270

$\eta = 98\%$

Luminaire: LEDiL Oy CS14764_STRADA-2X2MX-VSM_(NV4x144A)
Lamps: 1 x Nichia_NV4x144A_1841.22lm@250mA_P=10.9615W_I=0.250A

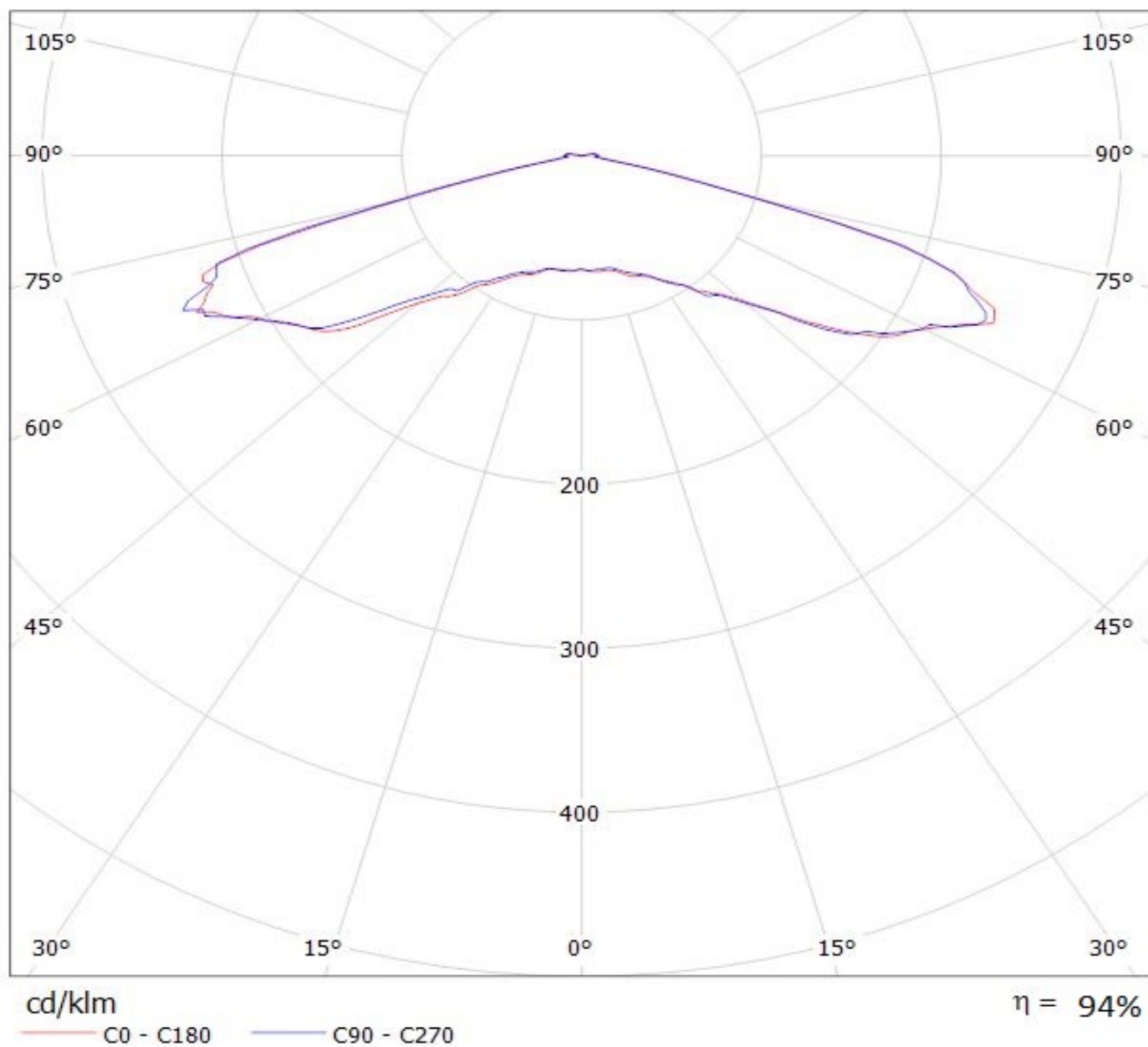

Luminaire: Ledil Oy CS14764_STRADA-2X2MX-VSM_NFMW488AR_SIMULATED
Lamps: 1 x NICHIA NFMW488AR

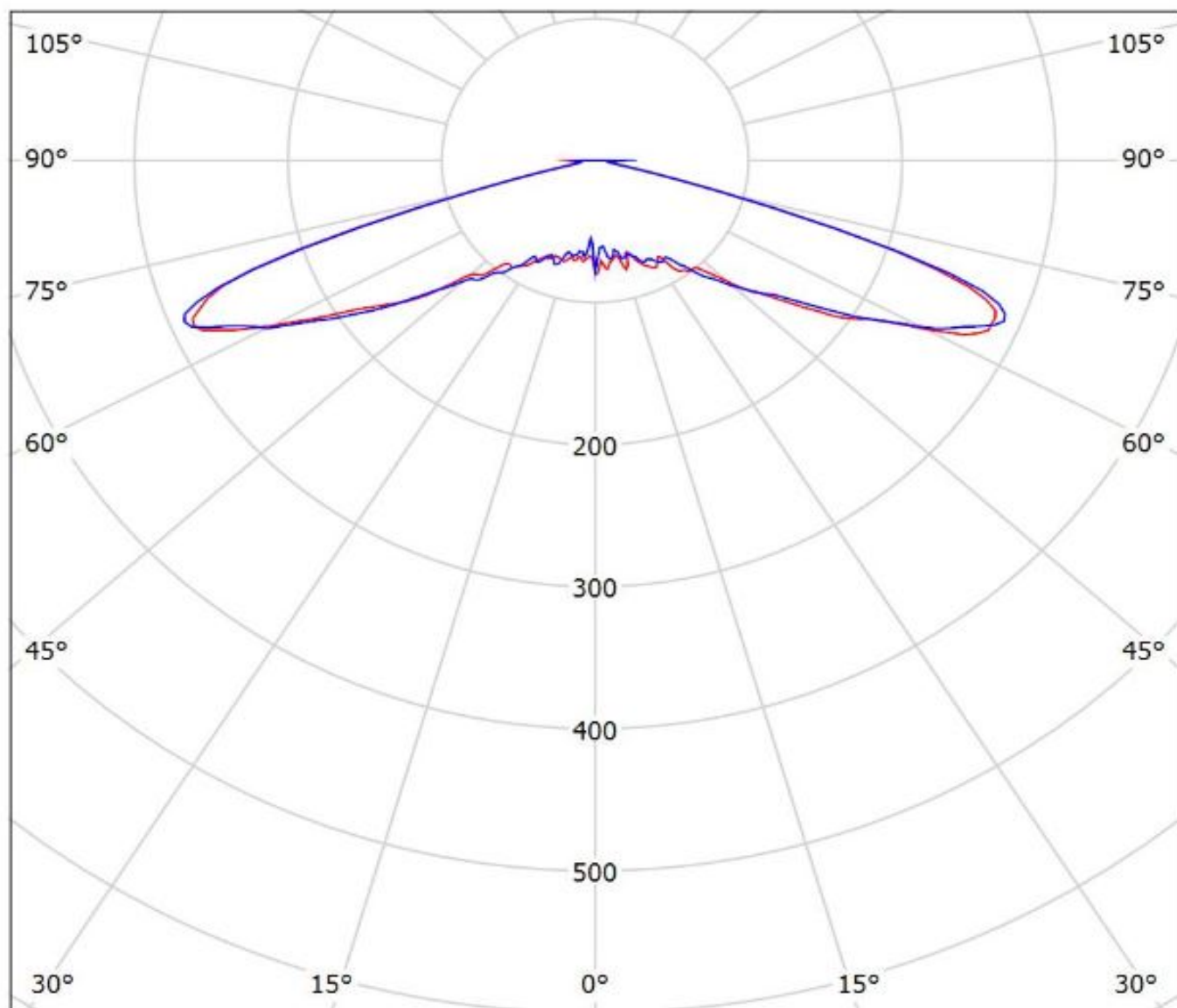

cd/klm
— C0 - C180 — C90 - C270

$\eta = 95\%$

NOTE: The typical divergence will be changed by different color, chip size and chip position tolerance. The typical total divergence is the full angle measured where the luminous intensity is half of the peak value.